

USER MANUAL

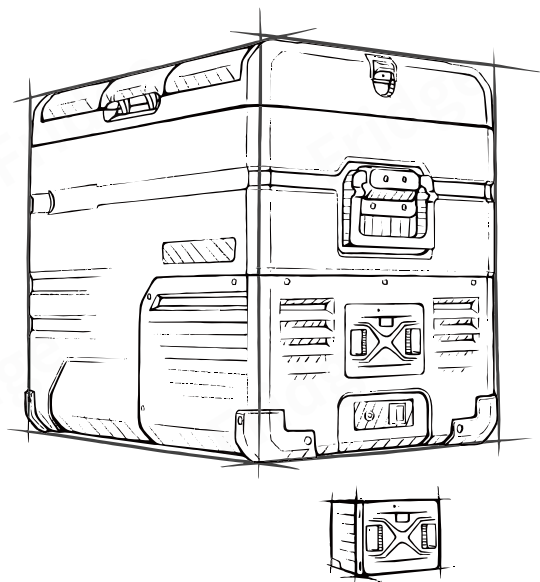

Model TW35 TW45 TW55

Please read this operating manual carefully before starting the device.
Keep it in a safe place for future reference.

CONTENTS

| | |
|--|-------|
| 1.SAFETY INSTRUCTIONS | Page1 |
| 2.PRODUCT FEATURES | Page2 |
| 3.PRODUCT STRUCTURE | Page2 |
| 4.REVERSE DOOR OPENING DIRECTION | Page3 |
| 5.FUNCTION AND OPERATION | Page4 |
| 6.BATTERY OPERATION | Page5 |
| 7.CARE AND MAINTENANCE | Page7 |
| 8.TROUBLESHOOTING | Page8 |
| 9.WARRANTY | Page9 |
| 10.TECHNICAL INFORMATION | Page9 |

1. SAFETY INSTRUCTIONS

WARNING!

- Do not operate the appliance if it is visibly damaged.
- Do not block the gaps of the fridge with things like pin, wire, etc.
- Do not expose the appliance to rain or soak it in water.
- Do not place the appliance near naked flames or other heat sources (heaters, direct sunlight, gas ovens etc.)
- Do not store any explosive substances like spray cans with a flammable propellant.
- Ensure the supply cord is dry and not trapped or damaged. Do not locate multiple portable socket-outlets or portable power supplies at the rear of the appliance.
- Check the voltage specification on the type plate corresponds to that of the energy supply. The appliance is only to be used with the power supply unit provided with the appliance.
- Do not use electrical appliances inside the food storage compartments of the appliance, unless they are of the type recommended by the manufacturer.
- Once unpacked and before turning on, the appliance must be placed on a level surface for more than 6 hours.
- Make sure that the appliance stays horizontally when it is running. The tilt angle must be less than 5° for long time running and be less than 45° for short time running.
- Keep the ventilation openings in the unit casing or in the built-in structure free of obstacles.
- Keep the appliance stable on the ground or in the car; Do not drain upside down.

CAUTION!

- Repairs may only be carried out by qualified personnel. Incorrect repair may cause danger. The lamp and supply cord must be replaced by the manufacturer or qualified persons.
- The installation of DC power in the boat must be handled by qualified electricians.
- The appliance can only use our dedicated rechargeable batteries, non-rechargeable batteries are prohibited, otherwise there may be a danger of fire and explosion.
- In use or during storage, battery found there has been high fever, leakage, odor, distortion and other anomalies, please stop using it immediately and stay away from the battery.
- Battery end of life should be immediately removed from the equipment, please properly handle security of spent batteries, do not put into fire or water.
- Children shall not play with the appliance. Cleaning and user maintenance shall not be made by children without supervision.
- The appliance can be used by children aged from 8 years and above and persons with reduced physical, sensory or mental capabilities or lack of experience and knowledge if they've been given supervision or instruction concerning use of the device in a safe way and understand the hazards.

NOTICE!

- Disconnect the power supply before each cleaning and maintenance and after every use.
- Do not use sharp tools to defrost; Do not damage the refrigerant circuit.

- Risk of child entrapment. Before you throw away your old refrigerator or freezer: take off the doors: leave the shelves in place so that children may not easily climb inside.
- Check if the cooling capacity of the appliance is suitable for storing the food or medicine. Food may only be stored in its original packaging or in suitable containers.
- If the appliance is left empty for long periods, switch off, defrost, clean, dry, and leave the door open to prevent mould developing within the appliance.
- The appliance is intended to be used in household and similar applications such as:
 - Staff kitchen areas in shops, offices and other working environments;
 - Camping, Farm houses and by clients in hotels, motels and other residential environments;
 - Bed and breakfast type environments;
 - Catering and similar non-retail applications.
- Information, illustrations and specifications in this manual reflect the most current available at the time of publication, are subject to change without prior notice.

 Please according to local regulations regarding disposal of the appliance for its flammable refrigerant and blowing gas.

2.PRODUCT FEATURES

- High-efficiency DC compressor and conversion module.
- CFC free and great heat insulation.
- Lowest cooling to -20°C/-4°F(based on 25°C/77°F room temperature).
- Intelligent battery protection system prevents your vehicle from running out of battery.
- LED display control panel for temperature setting, USB charging port: 5V/1A.
- Detachable lithium battery: 15600mAh/11.1V.
- Specific parts: drain plug, cupholder door, interior LED light, cutting board, bottle opener.

3.PRODUCT STRUCTURE

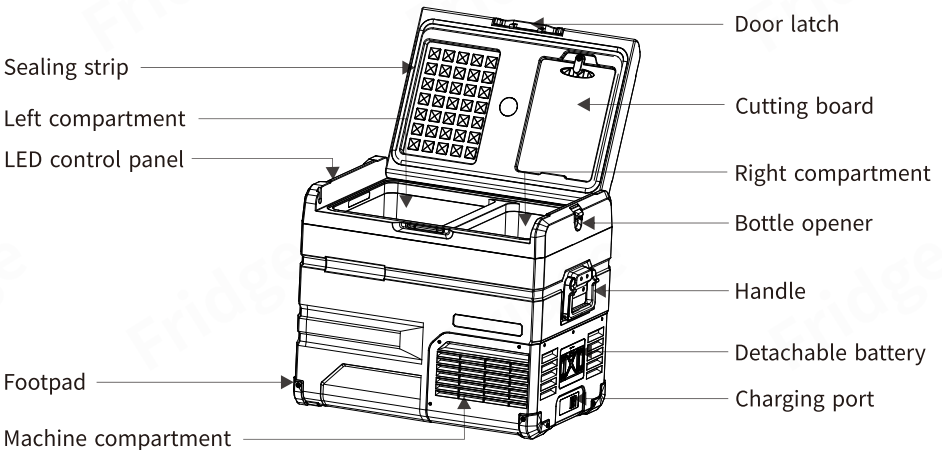

Note: The cutting board can be moved by turning the knob on the top cover, it is suggested to clean and dry it after every use.

4. REVERSE DOOR OPENING DIRECTION

The door opening direction can be changed according to actual needs, please follow the instructions below:

Door Disassembly:

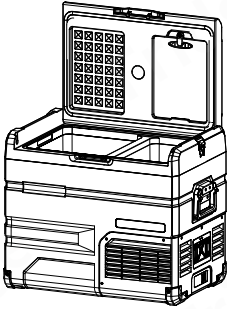

Open the door at a 90° angle

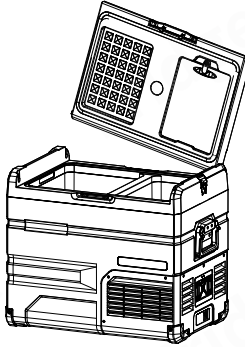

Take off the door from one side

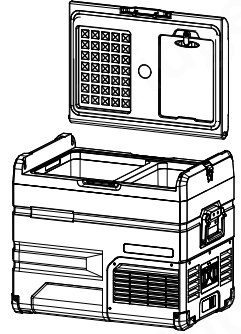

Take off the door from the other side

Door Installation:

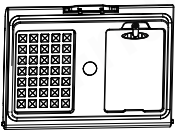

Reverse the door opening direction

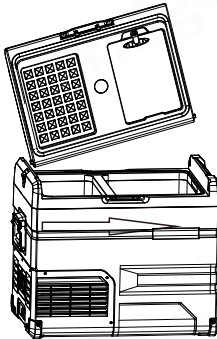

Align the door shaft with the hole on one side and insert it

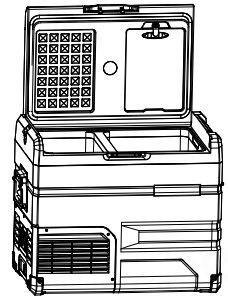

Fix the door on the other side, installation finished

5. FUNCTION AND OPERATION

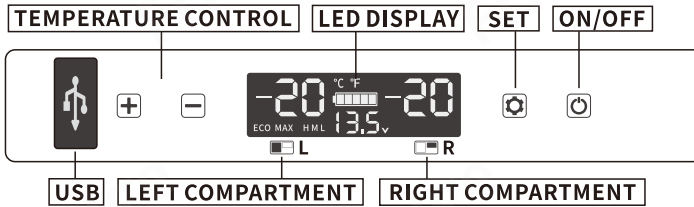

* **Note:** the right compartment is on the side where the compressor is.

- **Power supply:** connect to DC 12V/24V or AC 100~240V(using dedicated adapter) or solar (12~50V) power supply.
- **Display Screen Initialization:** when the fridge is powered on, the buzzer will make a long beep, and the display will be on for two seconds then enter the standby mode.
- **Power On/Off:** press to switch ON, **long** press for three seconds to switch OFF.
- **Temperature Setting:** under the running state, long press **+** and at the same time for three seconds to switch ON/OFF the left compartment, long press **-** and at the same time for three seconds to switch ON/OFF the right compartment, two compartments cannot be switched off at the same time.

When both left and right compartments are set in running state, press **+** or **-** to enter left compartment temperature setting, press **+** to increase temperature, press **-** to decrease temperature, and press to switch left/right compartment. The setting will be saved after stop operating for four seconds(Note: the temperature displayed is the current temperature of the compartments, it'll take a while to reach the set temperature.)

Temperature setting range: -20~20°C (-4~68°F)



- **Cooling Mode:** under the running state, press to switch MAX(fast cooling) and ECO (Energy saving Mode).(*Factory setting is MAX.)
- **Battery Protection Mode:** under the running state, long press for three seconds until screen flashes, then press again to select protection mode H(High), M(Medium) and L(Low) (*Factory setting is H.)







Voltage Reference:

| INPUT MODE | DC 12V | | DC 24V | |
|---------------|---------|--------|---------|--------|
| | CUT OUT | CUT IN | CUT OUT | CUT IN |
| L | 8.5V | 10.9V | 21.3V | 22.7V |
| M | 10.1V | 11.4V | 22.3V | 23.7V |
| H | 11.1V | 12.4V | 24.3V | 25.7V |

* the voltage is theoretical value, there may be a deviation in different sceneries.

* H should be set when the product is connected to car power, and M or L should be set when it is connected to a portable battery or other back-up battery.

- **Temperature Unit Setting:** switch off the fridge, long press  for 3 seconds until displays E1, and switch to E5 by pressing  again, then press **+** or **-** to switch Celsius or Fahrenheit. (*Factory setting is °C.)
- **Reset:** switch off the fridge, long press  for 3 seconds until displays E1, under E1 mode, long press **+** **-** at the same time for seconds to reset the settings.
- **Recommended temperature for common food:**

| | | | | | | |
|--|---|---|---|---|---|---|
|  |  |  |  |  |  |  |
| Drinks | Fruits | Vegetable | Delicatessen | Wine | Ice cream | Meat |
| 5°C/41°F | 5~8°C/41~46°F | 3~10°C/37~50°F | 4°C/39°F | 10°C/50°F | -10°C/14°F | -18°C/0°F |

6. BATTERY OPERATION

***Note:** The old model battery has a DC charging port on the side, the new model battery does not have DC charging port, refer to the instructions below for more details. It is recommended to use the new model battery.

- **Battery ON/OFF:** long press the power button on the battery to switch ON/OFF. When the battery is OFF, short press the power button to show current battery.

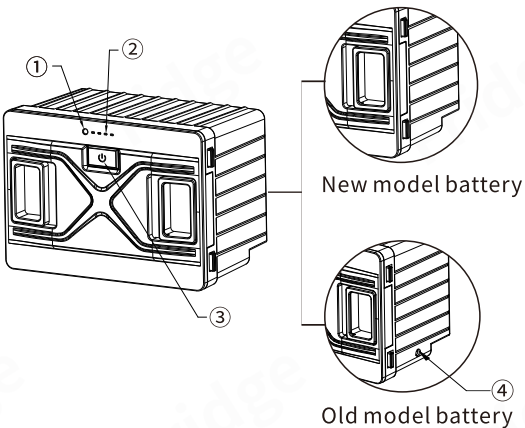

Model: FSAK-002

Capacity: 15600mAh/173Wh

Rated Voltage: 11.1V

①Power Indicator

(Green: charging; Blue: discharging)

②Battery Indicator (show current battery)

③Power Button

④DC Charging Port

(old model battery only)

Charging Limited Voltage(DC): 12.6V

Charging Limited Current(DC): 3A

⚠ Warning:

do not disassemble the battery!

• **Battery charging (for reference only):**

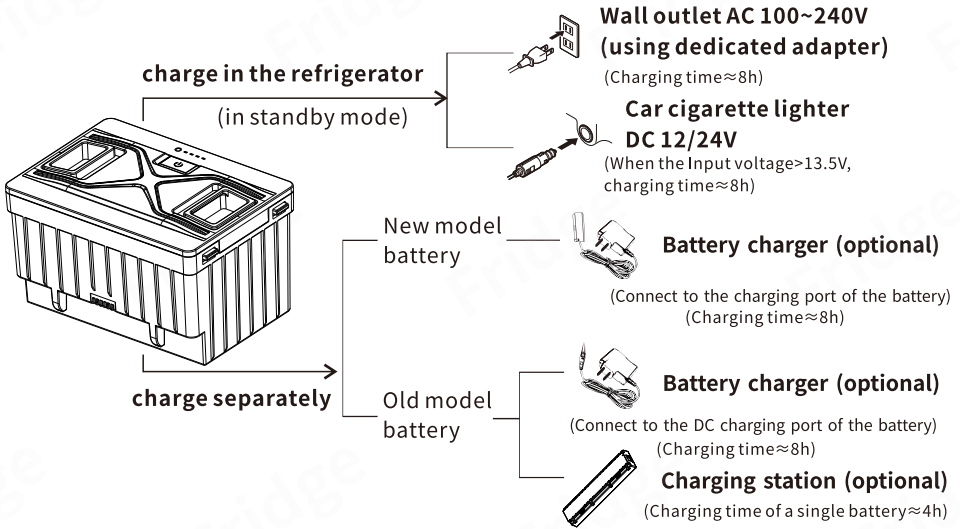

Note: It is suggested to switch off the refrigerator when charging the battery (the power supply may mainly power the compressor when the refrigerator is running).

When connect to a solar panel, please place the refrigerator in a cool place to dissipate heat. The charging input power should be higher than the working power of the refrigerator (about 40-45W), or switch off the refrigerator, otherwise the battery will run out.

It is suggested to use 100W solar panel.

MAX Solar Input Voltage: 50V; MAX Solar Input Current:10A.

Note: the output of the solar panel is unstable, so it cannot power the refrigerator directly. When using a solar panel, the battery should be put into the refrigerator.

• **Discharging time (for reference only):** In the low battery protection mode, the battery can last about 4 hours after being fully charged. When the temperature of the refrigerator is set between 2~8°C (ambient temperature 25°C), it can last 12 hours after the internal temperature stabilizes. Remove or switch off the battery to prevent self-discharge when not in use.

7. CARE AND MAINTENANCE

■ Cleaning:

- Switch off and unplug the device first to avoid electric shock.
- Remove the cover and drain from the hole at the bottom of the device.
- Use wet cloth to clean the device and dry it.
- Do not soak the fridge in water and do not wash it directly.
- Do not use abrasive cleaning agents during cleaning as these can damage the device.

■ Storage:

If the device will not be in use for a long time, please follow the instruction:

- Switch off and unplug the device.
- Take out all the items stored in the device.
- Wipe off excess water with a soft rag.
- Put the device in a cool and dry place.
- Leave the lid slightly open to prevent odors from forming.
- Recommended storage environment:
ambient temperature: 25°C, ambient humidity: $\leq 75\%$.

■ Defrosting:

Humidity can form frost in the interior of the cooling device or on the evaporator. This reduces the cooling capacity. Defrost the device in good time to avoid this.

- Switch off and unplug the device first to avoid electric shock.
- Take out all the items stored in the device.
- Keep the lid open.
- Wipe off the defrosted water.



Never use hard or pointed tools to remove ice or to loosen objects which have frozen in place.

8.TROUBLESHOOTING

| Issues | Cause/Suggestions |
|--|--|
| Refrigerator does not work | <ul style="list-style-type: none"> • Check if the switch is on. • Check if the plug and socket are connected well. • Check if the fuse has been burnt. • Check if the power supply is malfunctioned. • Switch on/off the fridge frequently may cause start delay of the compressor. |
| Refrigerator compartments are too warm | <ul style="list-style-type: none"> • The door is opened frequently. • A large amount of warm or hot food was stored recently. • The refrigerator has been disconnected for a long time. |
| Food is frozen | <ul style="list-style-type: none"> • The temperature was set too low. |
| There is "water flow" noise from inside the refrigerator | <ul style="list-style-type: none"> • It's a normal phenomenon, caused by the flow of refrigerant. |
| There are waterdrops around the refrigerator casing or door gap | <ul style="list-style-type: none"> • It's a normal phenomenon, the moisture will condense to water when it touches a cold surface of the refrigerator. |
| The compressor is slightly noisy when starting | <ul style="list-style-type: none"> • It's a normal phenomenon, the noise will be reduced after the compressor works stably. |
| Code F1 displayed | <ul style="list-style-type: none"> • Possible cause: low voltage to fridge. Adjust the battery protection from High to Medium or from Medium to Low. |
| Code F2 displayed | <ul style="list-style-type: none"> • Possible cause: condenser fan is overloaded. Disconnect power to fridge for 5 minutes & re-start. If the code shows again, contact manufacturer for service. |
| Code F3 displayed | <ul style="list-style-type: none"> • Possible cause: the compressor starts too frequently. Disconnect power to fridge for 5 minutes & re-start. If the code shows again, contact manufacturer for service. |
| Code F4 displayed | <ul style="list-style-type: none"> • Possible cause: compressor not kicking in. Disconnect power to fridge for 5 minutes & re-start. If the code shows again, contact manufacturer for service. |
| Code F5 displayed | <ul style="list-style-type: none"> • Possible cause: overheating of the compressor & electronics. Disconnect power to fridge for 5 minutes & re-start. If the code shows again, contact manufacturer for service. |
| Code F6 displayed | <ul style="list-style-type: none"> • Possible cause: no parameter can be detected by the controller. Disconnect power to fridge for 5 minutes & re-start. If the code shows again, contact manufacturer for service. |
| Code F7 or F8 displayed | <ul style="list-style-type: none"> • Possible cause: temperature sensor is faulty. Contact manufacturer for service. |

*For models with FSAK-002 detachable battery, if code F1 displayed, unplug or turn off the battery, or connect to DC12/24V/AC100-240V(using the adapter) power supply to power the compressor and battery in time to avoid long-term micro-current draining the battery.

9.WARRANTY

If the device gets malfunctional, limited warranty will be provided for 1 year from the date of purchase, except following situations:

- Contrived damage.
- Damage caused by force majeure such as earthquake, conflagration, etc.
- Damage from inappropriate use or violating this instruction.
- Damage or malfunction caused by disassembling.

10.TECHNICAL INFORMATION

| MODEL | TW35 | TW45 | TW55 |
|---------------------------|--|---|---|
| RATED VOLTAGE | DC12/24V or AC100~240V(using dedicated adapter) or Solar(12~50V) | | |
| RATED POWER | 60W | | |
| CAPACITY | 37.5L/1.32cu.ft. | 45.6L/1.61cu.ft. | 54.2L/1.91cu.ft. |
| NOISE | ≤45dB | | |
| TEMPERATURE SETTING RANGE | -20~20°C (-4~68°F) | | |
| CLIMATE CATEGORY | T/ST/N/SN | | |
| DIMENSIONS(L*W*H) | 647*400*441mm 25 1/2 *15 3/4 *17 3/8inch | 647*400*506mm 25 1/2 *15 3/4 *19 15/16inch | 647*400*571mm 25 1/2 *15 3/4 *22 1/2inch |
| NET WEIGHT | 15.5kg/34.2lb (not including battery) | 16.5kg/36.4lb (not including battery) | 17.2kg/37.9lb (not including battery) |

*Due to product improvement, the technical information might be different from actual information, please refer to the rating label on the product.